

Das "weiße" Wasserrohr - System bringt Sicherheit

DURETTE X[®]

Preisliste A2/08

Material PPRC

keine Kalkablagerungen
kein Lochfraß

Schmelzstellen

absolute Dichtigkeit durch Verschmelzung
nur eines einzigen Materials

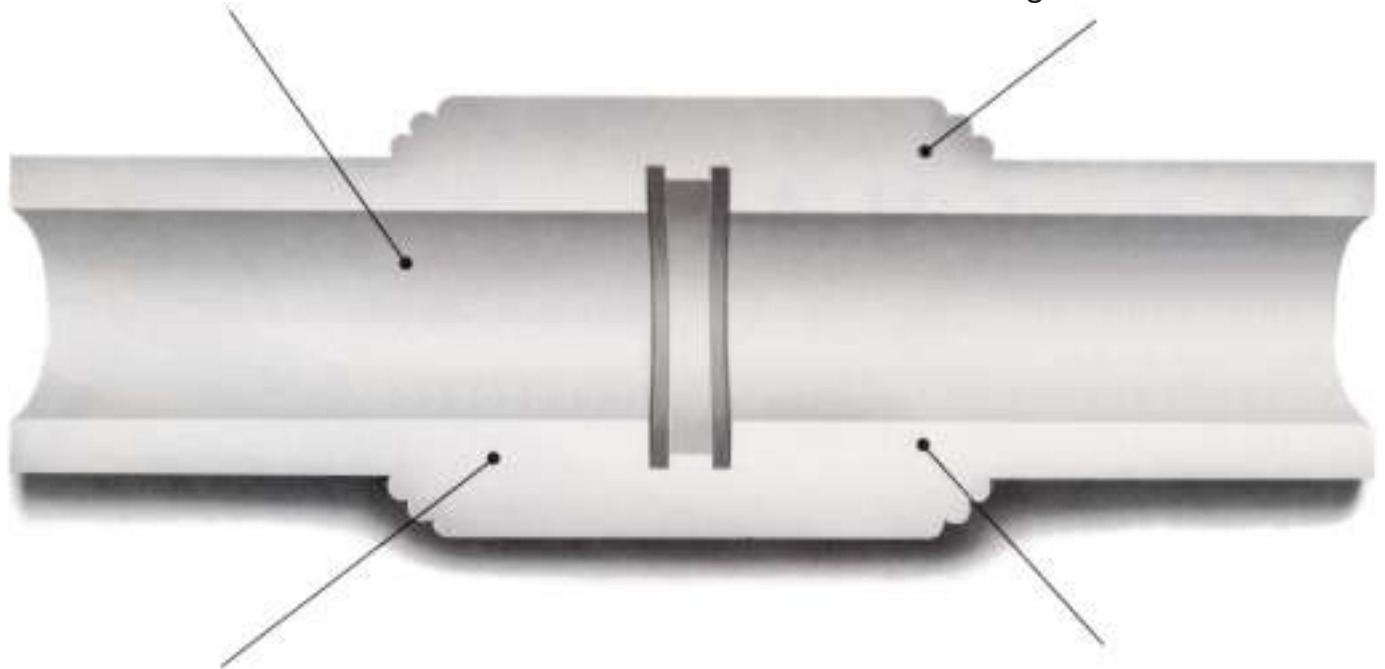

Verarbeitung

einfachste Handhabung durch
Zusammenstecken der einzelnen
Elemente nach Erhitzen

Dickwandigkeit

Fliessgeräuschdämmung, die
sonst nur durch zusätzliche
Isolierung erzielt werden kann

DURETTE X GmbH & Co. KG

Panzerstrasse o.Nr.
52372 Kreuzau-Stockheim

Tel. : +49 (24 21) 9 57 1- 0
Fax.: +49 (24 21) 9 57 1- 22

EMPFOHLENE VERKAUFSPREISLISTE A2/08

Art.-Nr	Maße	Preis EUR	VE	Artikel
99200	20 x 3,4 mm	m 2,33	m 50	DURETTE X - Rohr PN 20 in Stangen á 2,50m
99250	25 x 4,2 mm	4,23	50	
99300	32 x 5,4 mm	6,35	50	
99080	20 x 3,4 mm	3,50	62,5	DURETTE X - AL-Rohr Alu - Ummantelung PN 20 Außenhülle trans. in Stangen á 2,50m
99081	25 x 4,2 mm	4,88	62,5	
99082	32 x 5,4 mm	6,70	62,5	
99201	20 mm	1,76	Stk. 10	Muffe
99251	25 mm	1,98	10	
99301	32 mm	2,31	10	
99202	20 mm	2,12	10	Winkel 90°
99252	25 mm	2,25	10	
99302	32 mm	3,18	10	
99213	20 mm	2,17	10	Winkel 45°
99214	25 mm	2,33	10	
99215	32 mm	3,09	10	
99203	20 mm	2,71	10	T - Stück
99253	25 mm	3,20	10	
99303	32 mm	3,72	10	
99204	25 / 20 mm	1,60	10	Reduzierstück
99304	32 / 20 mm	2,55	10	
99354	32 / 25 mm	2,66	10	
99206	20 x 1/2 "	6,18	10	Unterputzwandscheibe mit Innengewinde
99256	25 x 3/4 "	6,48	10	
99238	8 mm	0,83	10	
				Unterlegscheibe

Art.-Nr	Maße	Preis EUR	VE	Artikel
99207	20 x 1/2 " IG	Stk. 5,42	Stk. 10	Übergangsstück rund
99257	25 x 3/4 " IG	6,07	10	
99307	32 x 1" IG	12,19	5	Übergang 6-Kant Schlüsselfläche
99208	20x1/2 " AG	6,07	10	Übergangsstück rund
99258	25x3/4 " AG	6,81	10	
99308	32 x 1" AG	13,71	5	Übergang 6-Kant Schlüsselfläche
99223	20 mm	3,69	10	Überspringbogen
99224	25 mm	3,91	10	
99225	32 mm	4,83	5	
99231	20 mm	1,74	10	Endkappe
99232	25 mm	2,17	10	
99233	32 mm	2,68	5	
99241	20 x 3/4 " IG	10,57	10	Übergangswinkel
99242	20 x 1/2 " IG	7,45	10	
99243	25 x 3/4 " IG	10,90	10	
99244	25 x 1/2 " IG	7,45	10	
99245	32 x 3/4 " IG	11,08	5	
99246	32 x 1 " IG	20,44	5	
99850	25x1/2 " AG	8,48	10	Übergangswinkel
99851	20x1/2 " AG	8,48	10	
99852	20x3/4 " AG	13,17	10	
99853	25x3/4 " AG	13,17	10	
99854	32x3/4 " AG	13,17	5	
99855	32x 1 " AG	24,93	5	

Art.-Nr	Maße	Preis EUR	VE	Artikel	Art.-Nr	Maße	Preis EUR	VE	Artikel
99116	20x½“ M * R 1“	19,78	5	Übergangsverschraubung mit Innengewinde	99901	½“ x 20 M * R ¾“	11,60	1	Übergangsverschraubung Messing / PPRC
99118	25 x ¾“ M * R 1¼“	28,59	5		99902	¾“ x 25 M * R 1“	17,24	1	
99120	32 x 1“ M * R 1½“	31,87	5		99903	1“ x 32 M * R 1¼“	26,42	1	
					99904	1“ x 32 M * R 1½“	34,50	1	
99115	20 x ½“ M * R 1“	21,17	5	Übergangsverschraubung mit Außengewinde	99291	20 mm	17,34	1	Absperrventil für Aufputzmontage
99117	25 x ¾“ M * R 1¼“	29,43	5		99292	25 mm	17,34	1	
99119	32 x 1“ M * R 1½“	33,09	5		99295	20 mm	27,64	1	Absperrventil für Unterputzmontage
					99296	25 mm	27,64	1	
99610	20 mm M * R 1“	10,98	1	Übergangsverschraubung ohne Gewindeteil	99209	½x15mm AG	6,83	10	Schneidring-Verschraubung.
99611	25 mm M * R 1¼“	11,27	1		99269	½x16mm AG	7,70	10	
99612	32 mm M * R 1½“	12,93	1		99210	½x18mm AG	8,84	10	
					99259	¾x22mm AG	9,19	10	
				99211	½x20mm AG	22,20	1	GEBO - Verschraubung	
				99212	¾x25mm AG	24,91	1		
99261	20 x ½“ x 20	7,59	10	Übergangs T-Stück IG	99205	20 mm	0,75	50	Rohrschelle
99262	20 x ¾“ x 20	8,46	10		99255	25 mm	0,95	50	
99263	25 x ½“ x 25	7,59	10		99355	32 mm	1,15	50	
99264	25 x ¾“ x 25	8,46	10						Schmelzgerät
99265	32 x ¾“ x 32	9,54	5						
99266	32 x 1“ x 32	19,08	5						
99267	20 x ½“ x 20	7,59	10	Übergangs T-Stück AG	99100	½“, ¾“	107,37	1	Adapter 32mm Adapter 40mm Schmelzgeräthalter
					99101	½“, ¾“, 1“	153,39	1	
					99013		17,90	1	
					99014		17,90	1	
					99030		15,80	1	
					99031		232,18	1	Materialkoffer incl. Schmelzgerät, Halter Rohrschere, Adapter
99271	25 x 20 x 25	2,90	10	T-Stück reduziert					
99272	32 x 20 x 32	4,50	10						
99273	32 x 25 x 32	4,50	10		99035		20,71	1	Rohrschere

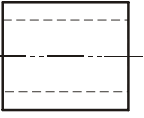
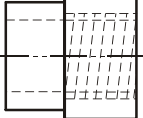
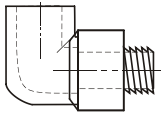
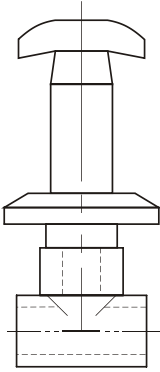
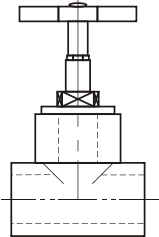
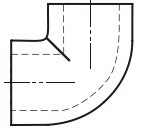
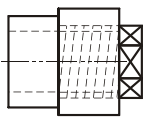
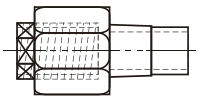
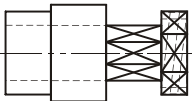
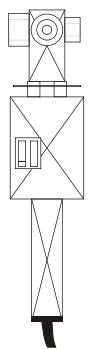
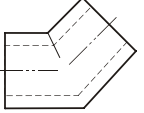
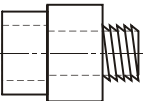
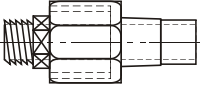
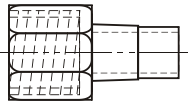
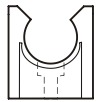
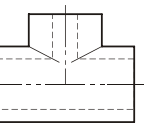
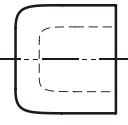
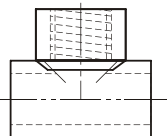
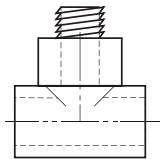
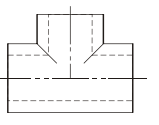
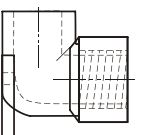
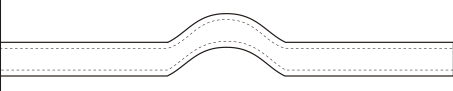
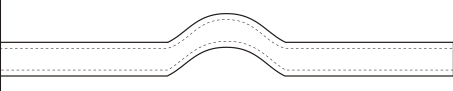
				
Muffe	Übergang rund IG	Übergangswinkel AG	Absperventil für Unterputzmontage	Absperventil für Aufputzmontage
				
Winkel 90°	Übergang 6-Kant IG	Übergangverschraubung IG	Übergangverschraubung Messing/ PPRC	Schmelzgerät
				
Winkel 45°	Übergang rund AG	Übergangverschraubung AG	Übergangverschraubung ohne Gewinde	Rohrschelle
				
T-Stück	Endkappe	Übergangs- T-Stück IG	Übergangs- T-Stück AG	T-Stück reduziert
				Weitere Artikel auf Anfrage
Wandscheibe	Übergangswinkel IG	Überspringbogen		Weitere Artikel auf Anfrage

DURETTE X GmbH & Co. KG

Panzerstrasse o.Nr.
52372 Kreuzau-Stockheim

Tel. : +49 (24 21) 9 57 1- 0
Fax.: +49 (24 21) 9 57 1- 22